



Thule Rapid System Kit 4039

> Instructions

LAND ROVER Range Rover Sport, 5-dr SUV, 14-

This kit is only for vehicles with flush or integrated side railing.

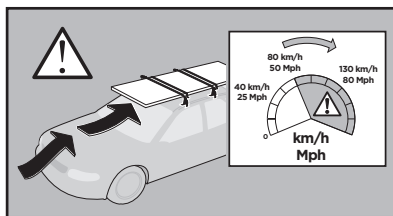
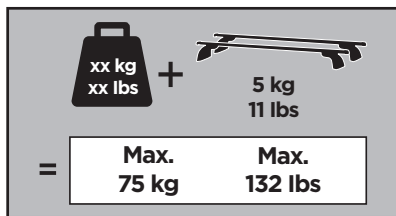
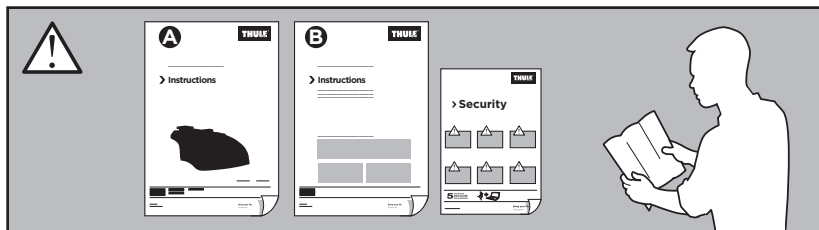

ISO 11154-E

184039

C.20141010
509-4039-01

Bring your life
thule.com



30349

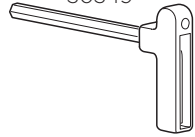

x1

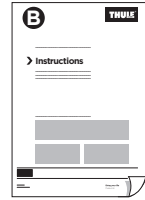

x1

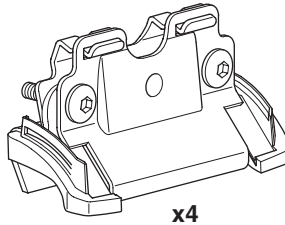

x4

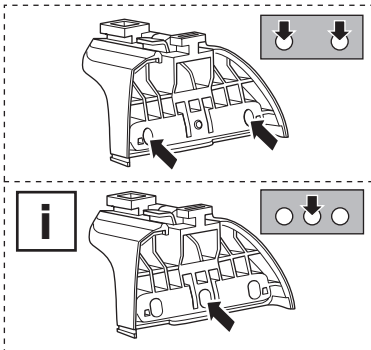

i

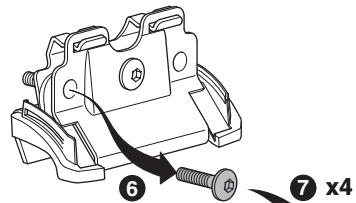
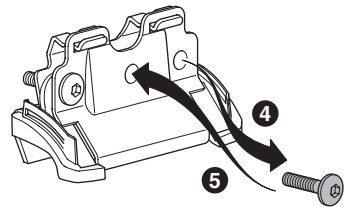
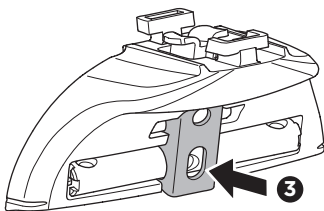
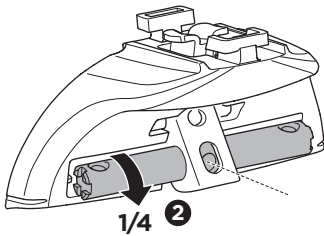
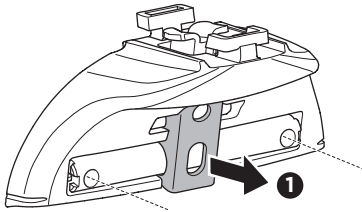
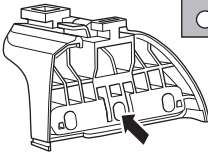

7 x4

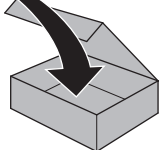

1

EN Only a few turns	ET Ainult mõni pööre	RO Doar câteva rotiri
DE Nur wenige Umdrehungen	LV Tikai daži apgriezieni	HU Csak néhány fordítás
FR Quelques tours uniquement	LT Tik keli pasukimai	EL Μόνο λίγες περιστροφές
NL Slechts enkele slagen	PL Wystarczy kilka obrotów	TR Yalnızca birkaç tur
IT Solo qualche giro	RU Только несколько оборотов	بعض دورات فقط AR
ES Sólo algunas vueltas	UK Лише декілька обертів	רק מספר סיבובים HE
PT Noções básicas	BG Само няколко завъртания	ZH 仅几圈
SV Endast några varv	CS Pouze několik otáček	JA 2～3回転のみ
DK Kun nogle få omgange	SK Len niekoľko otáčok	KO 몇 번만 돌리면 됨
NE Bare noen få omdreininger	SL Le nekaj obratov	TH เพียงสองสามรอบ
FI Vain muutama kierros	HR/BIH Samo nekoliko okreta	

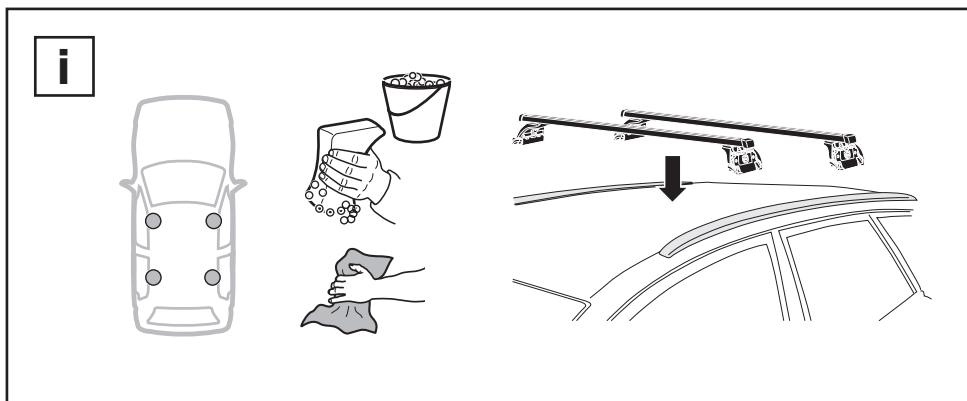
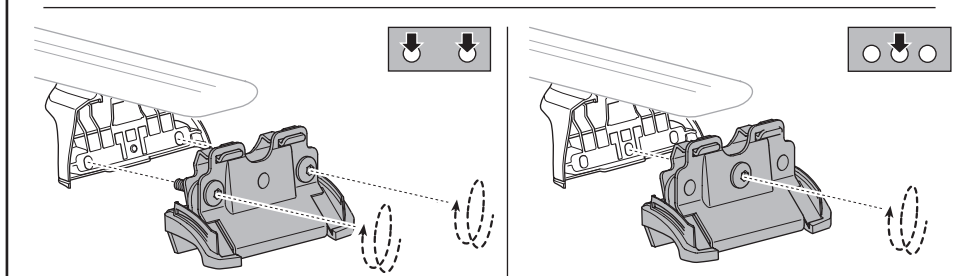
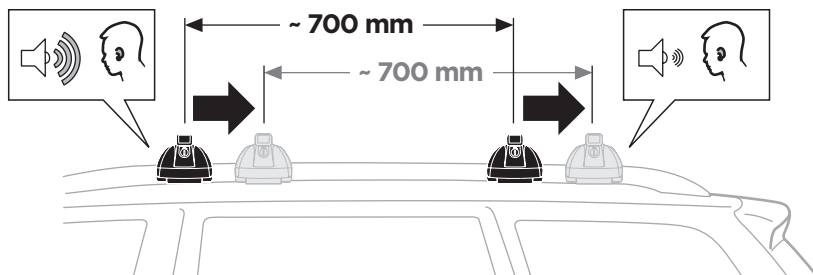
**2**

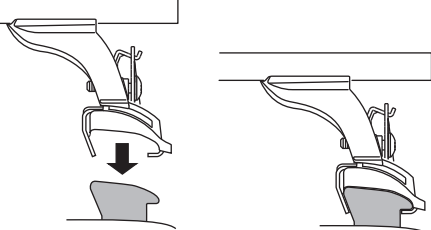
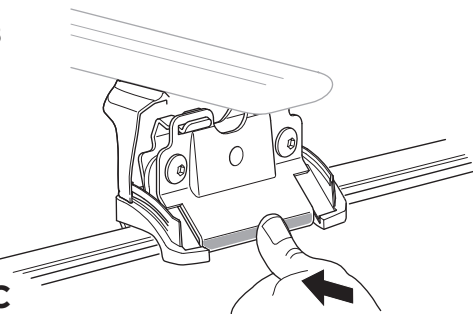
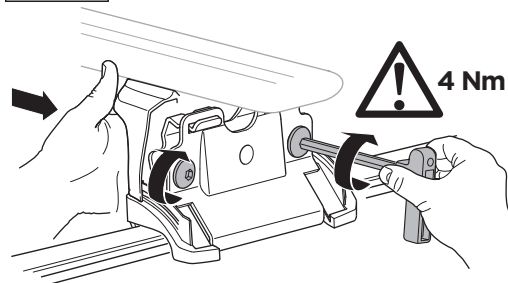
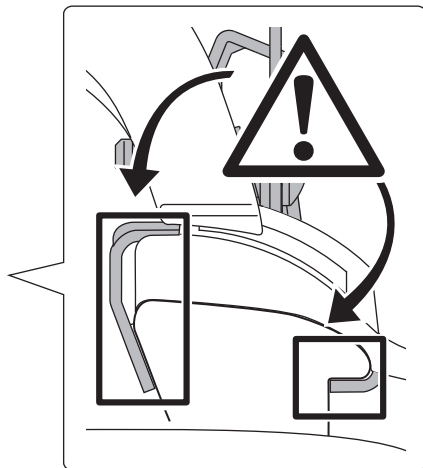
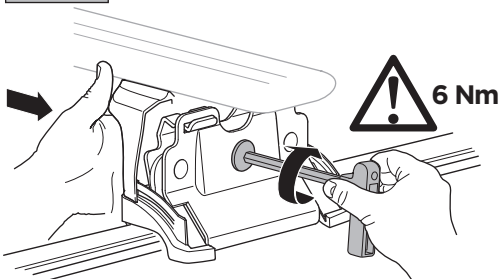
A**B****C****C**

- EN Tighten alternately
 DE Die Schrauben abwechselnd anziehen
 FR Serrer alternativement chaque côté
 NL Afwisselend aan de linker- en de rechterkant aandraaien
 IT Alternare il serraggio delle viti
 ES Apretar alternativamente
 PT Aperte alternadamente
 SV Dra åt växelvis
 DK Spænd skiftevis
 NE Trekk til vekselvis
 FI Kierrä vuorotellen
 ET Pinguldage vaheldumisi
 LV Pievelciēt pamišus
 LT Užsukinėkite pakaitomis
 PL Śruby dokręcaj naprzemiennie
 RU Затягивайте попеременно
 UK Затягти по чергово
 BG Затенете последователно
 CS Pokręťta bagazníka dokręcaj naprzemiennie.
 SK Dotahujte striedavo
 SL Privijajte izmenično
 HR/BIH Naizmjenično zategnite
 RO Strângeți alternativ
 HU Egymástól függetlenül szorítandó
 EL Σφιγίετε εναλλάξ
 TR Dönüşümlü sıkın

إحكام الربط بالتناوب AR
 交替拧紧 HE

- ZH 交替拧紧
 JA 自動固定
 KO 번갈아 조이기
 TH วนไปวนมาสลับ

