



Thule Rapid System Kit 4032

> Instructions

BUICK Encore, 5-dr SUV, 13-

OPEL Mokka, 5-dr SUV, 13-

VAUXHALL Mokka, 5-dr SUV, 13-

This kit is only for vehicles with flush or integrated side railing.

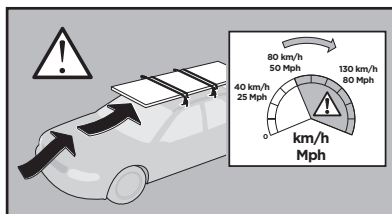
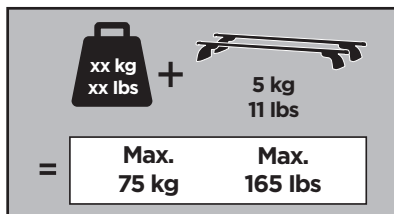
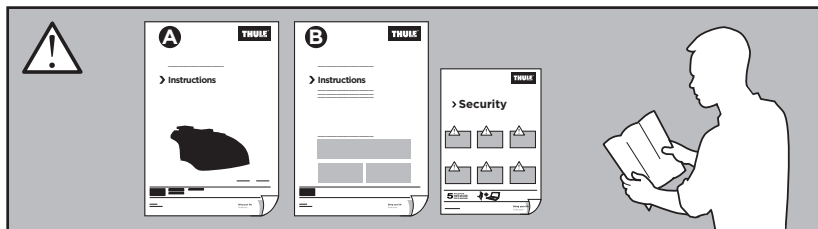

ISO 11154-E

184032

C.20130228
509-4032-01

Bring your life
thule.com

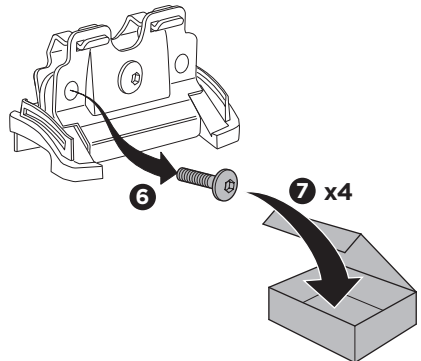
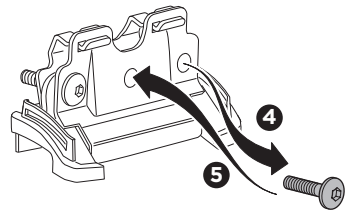
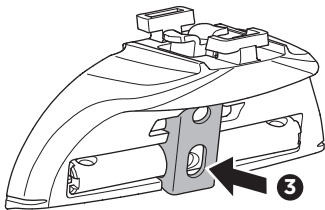
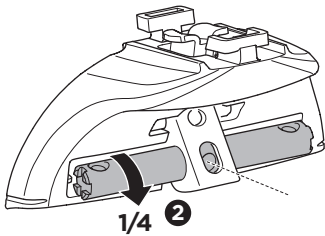
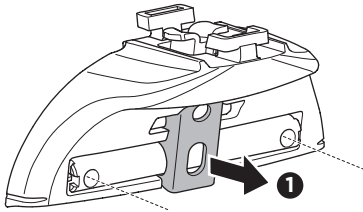
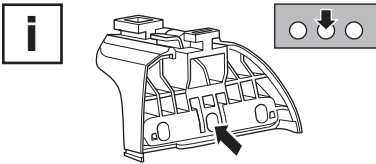
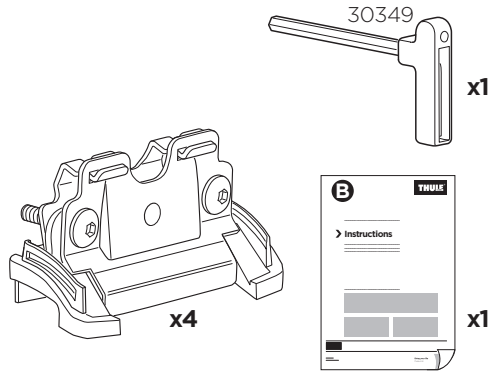
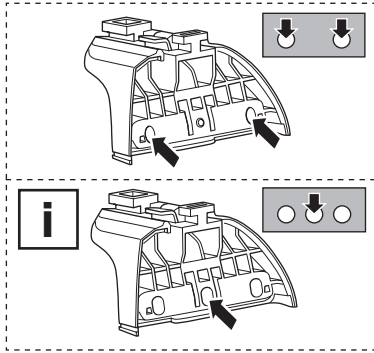

1

EN Only a few turns	ET Ainult mõni pööre	RO Doar câteva rotiri
DE Nur wenige Umdrehungen	LV Tikai daži apgriezieni	HU Csak néhány fordítás
FR Quelques tours uniquement	LT Tik keli pasukimai	EL Μόνο λίγες περιστροφές
NL Slechts enkele slagen	PL Wystarczy kilka obrotów	TR Yalnızca birkaç tur
IT Solo qualche giro	RU Только несколько оборотов	بعض دورات فقط AR
ES Sólo algunas vueltas	UK Лише декілька обертів	רק מספר סיבובים HE
PT Noções básicas	BG Само няколко завъртания	ZH 仅几圈
SV Endast några varv	CS Pouze několik otáček	JA 2～3回転のみ
DK Kun nogle få omgange	SK Len niekoľko otáčok	KO 몇 번만 돌리면 됨
NE Bare noen få omdreininger	SL Le nekaj obratov	TH เพียงสองสามรอบ
FI Vain muutama kierros	HR/BIH Samo nekoliko okreta	

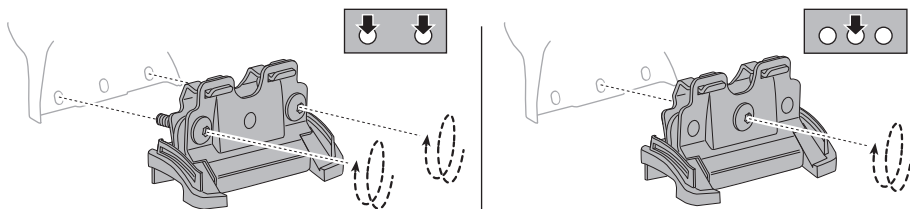
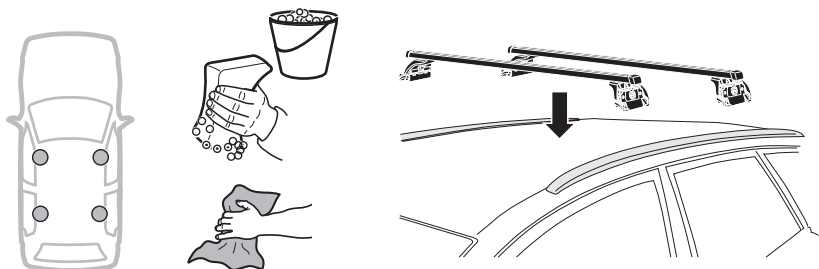
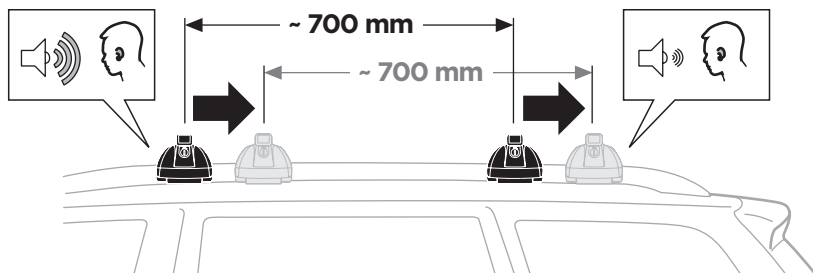
**i****2**

A

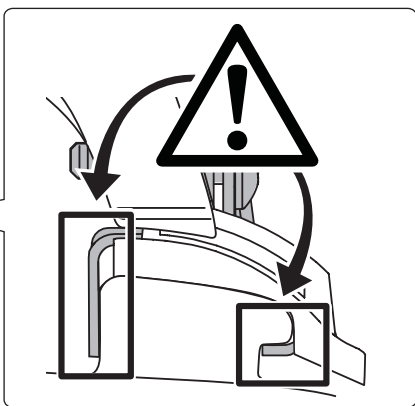
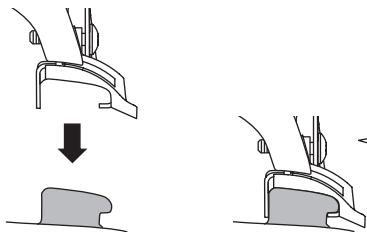

B

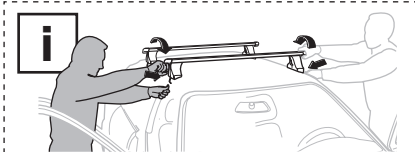
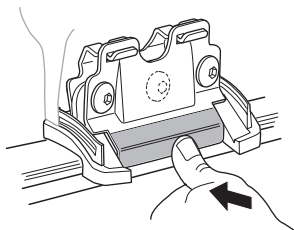

C

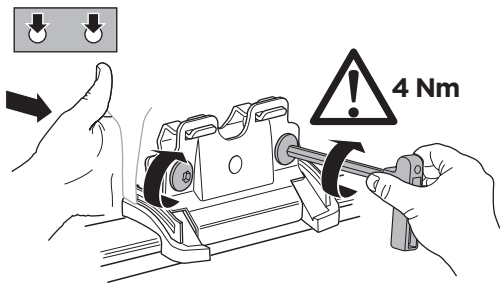

- EN Tighten alternately
- DE Die Schrauben abwechselnd anziehen
- FR Serrer alternativement chaque côté
- NL Afwisselend aan de linker- en de rechterkant aandraaien
- IT Alternare il serraggio delle viti
- ES Apretar alternativamente
- PT Aperte alternadamente
- SV Dra åt växelvis
- DK Spænd skiftevis
- NE Trekk til vekselvis
- FI Kierrä vuorotellen
- ET Pinguldage vaheldumisi
- LV Pievelciēt pamīšus
- LT Užsukinėkite pakaitomis
- PL Śruby dokręcaj naprzemiennie
- RU Затягивайте попеременно
- UK Затягти по чергово
- BG Затегнете последователно
- CS Pokręťta bagazníka dokręcaj dokręcaj naprzemiennie.
- SK Dotiahajte striedavo
- SL Privijajte izmenično
- HR/BiH Naizmjerno zategnite
- RO Strângeți alternativ
- HU Egymástól függetlenül szorítandó
- EL Ζφίγγετε εναλλάξ
- TR Dönüşümlü sıkın

C

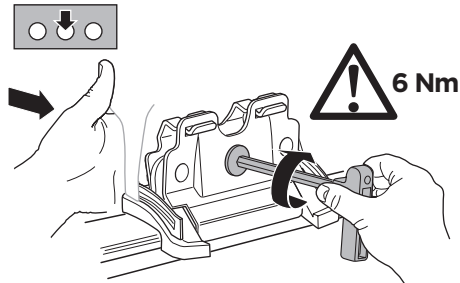

AR إحكام الربط بالتناوب
HE חזק לסיבובן

- ZH 交替拧紧
- JA 自動固定
- KO 번갈아 조이기
- TH สลับขันสลับ

