



## Thule Rapid System Kit 4028

# > Instructions

DACIA Lodgy, 5-dr MPV, 12-

This kit is only for vehicles with flush or integrated side railing.

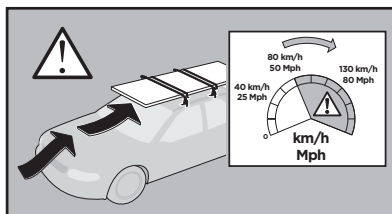
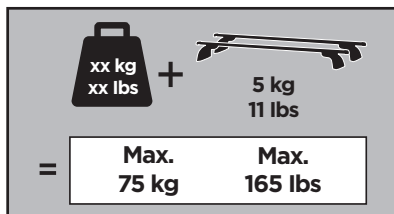
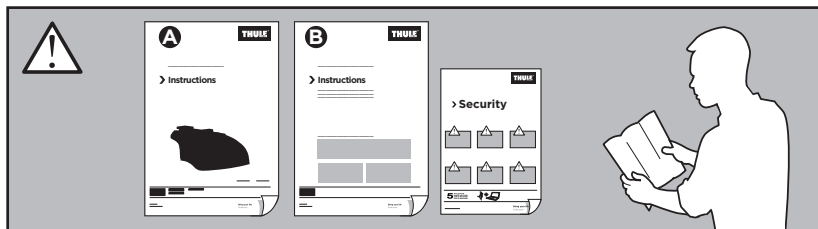

ISO 11154-E

184028

C.20130228  
509-4028-01

Bring your life  
thule.com

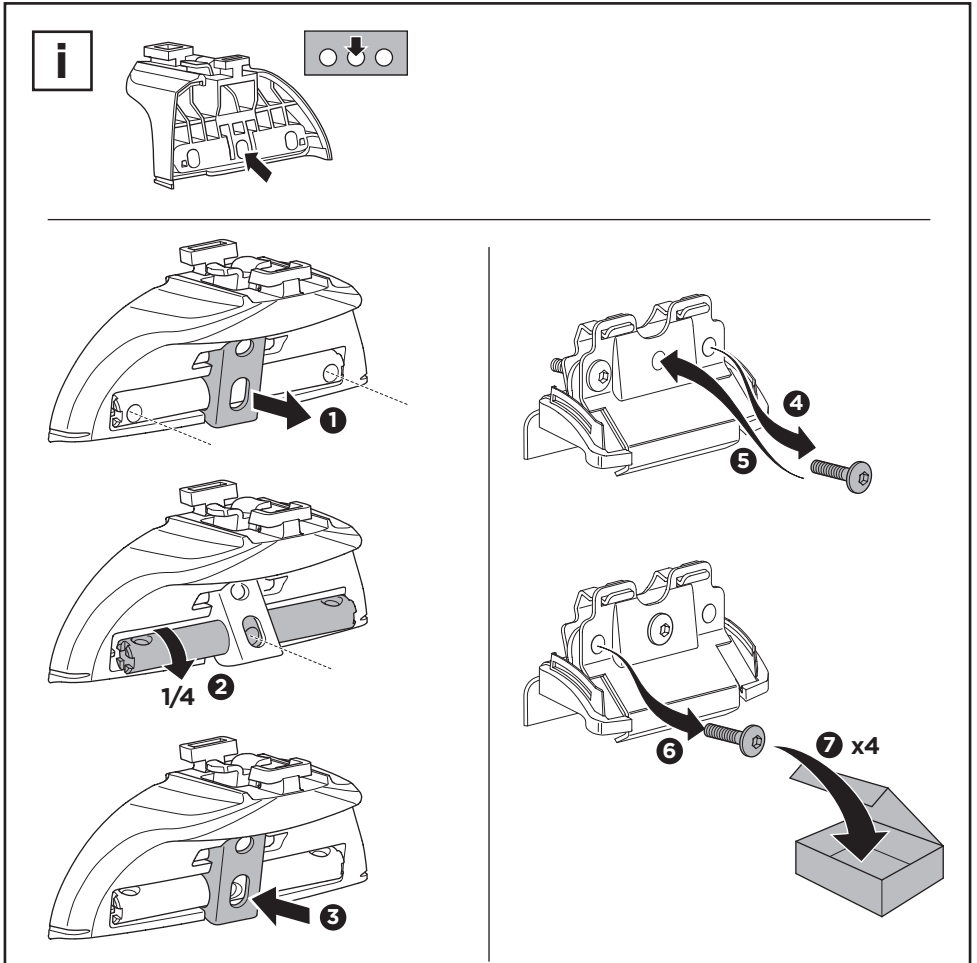
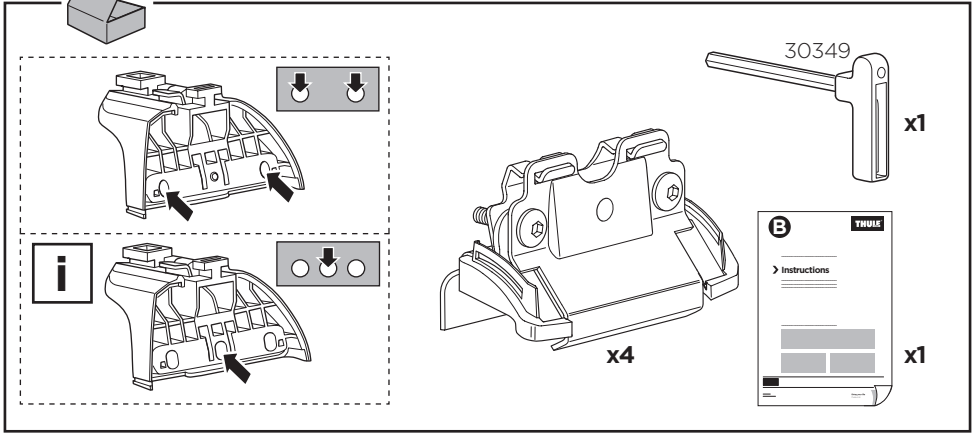

**1**

<b>EN</b>	Only a few turns	<b>ET</b>	Ainult mõni pööre	<b>RO</b>	Doar câteva rotiri
<b>DE</b>	Nur wenige Umdrehungen	<b>LV</b>	Tikai dažī apgrīzieni	<b>HU</b>	Csak néhány fordítás
<b>FR</b>	Quelques tours uniquement	<b>LT</b>	Tik keli pasukimai	<b>EL</b>	Μόνο λίγες περιστροφές
<b>NL</b>	Slechts enkele slagen	<b>PL</b>	Wystarczy kilka obrotów	<b>TR</b>	Yalnızca birkaç tur
<b>IT</b>	Solo qualche giro	<b>RU</b>	Только несколько оборотов		بعض دورات فقط
<b>ES</b>	Sólo algunas vueltas	<b>UK</b>	Лише декілька обертів		רק מספר סיבובים
<b>PT</b>	Noções básicas	<b>BG</b>	Само няколко завъртания	<b>ZH</b>	仅几圈
<b>SV</b>	Endast några varv	<b>CS</b>	Pouze několik otáček	<b>JA</b>	2～3回転のみ
<b>DK</b>	Kun nogle få omgange	<b>SK</b>	Len niekoľko otáčok	<b>KO</b>	몇 번만 돌리면 됨
<b>NE</b>	Bare noen få omdreininger	<b>SL</b>	Le nekaj obratov	<b>TH</b>	เพียงสองสามรอบ
<b>FI</b>	Vain muutama kierros	<b>HR/BIH</b>	Samo nekoliko okreta		

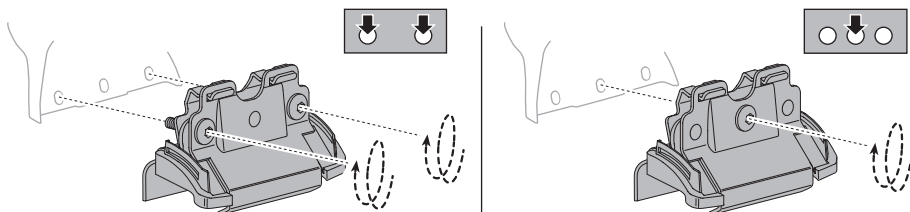
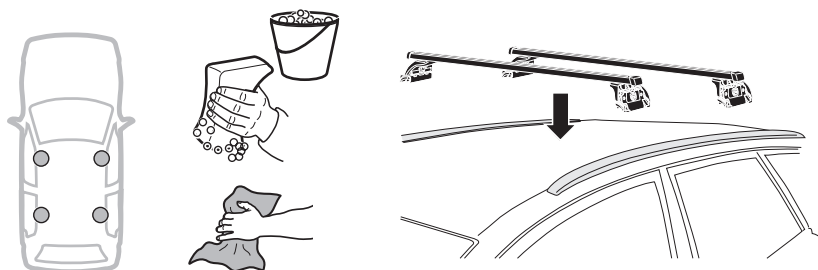
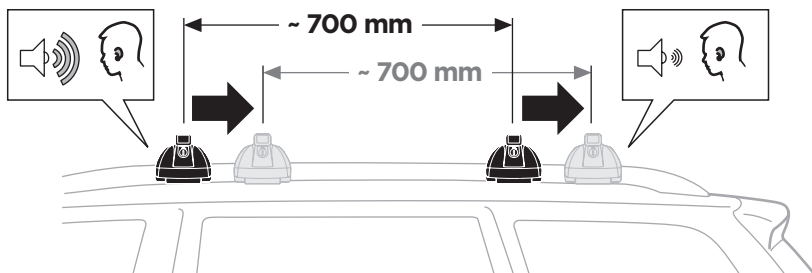
**i****2**

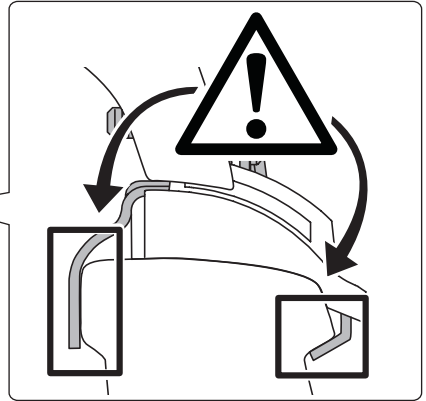
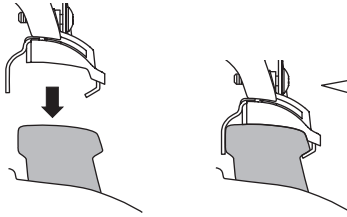
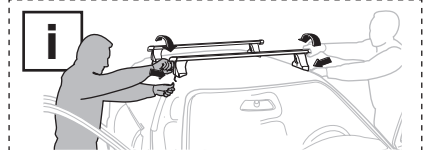
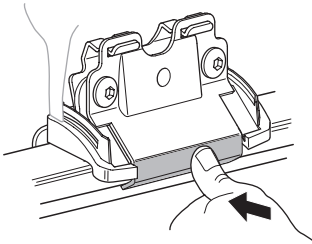
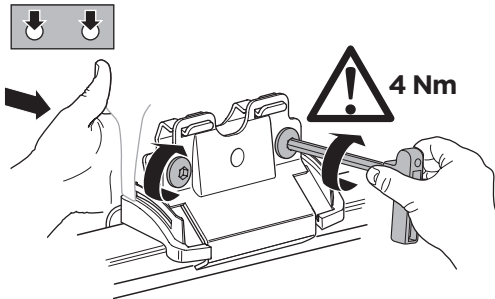
**A****B****C**

- EN** Tighten alternately  
**DE** Die Schrauben abwechselnd anziehen  
**FR** Serrer alternativement chaque côté  
**NL** Afwisselend aan de linker- en de rechterkant aandraaien  
**IT** Alternare il serraggio delle viti  
**ES** Apretar alternativamente  
**PT** Aperte alternadamente  
**SV** Dra åt växelvis  
**DK** Spænd skiftevis  
**NE** Trekk til vekselvis  
**FI** Kierrä vuorotellen  
**ET** Pinguldage vaheldumisi  
**LV** Pievelciēt pamīšus  
**LT** Užsukinėkite pakaitomis  
**PL** Śruby dokręcaj naprzemiennie  
**RU** Затягивайте попеременно  
**UK** Затягти по чергово  
**BG** Затегнете последователно  
**CS** Pokręťta bagazníka dokręcaj dokręcaj naprzemiennie.  
**SK** Doťahujte striedavo  
**SL** Privijajte izmenično  
**HR/BiH** Naizmjerno zategnite  
**RO** Strângeți alternativ  
**HU** Egymástól függetlenül szorítandó  
**EL** Ζφίγγετε εναλλάξ  
**TR** Dönüşümlü sıkın

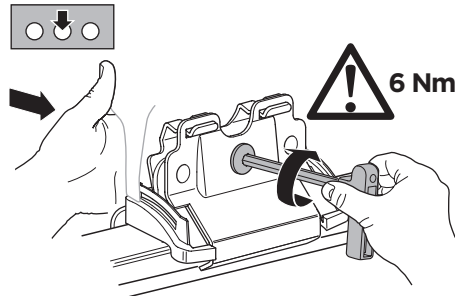
**C**

إحكام الربط بالتناوب **AR**  
 חזק לסיורון **HE**

- ZH** 交替拧紧  
**JA** 自動固定  
**KO** 번갈아 조이기  
**TH** ซลับแบบสลับ

