



## Thule XT Kit 3004

# > Instructions

**FIAT Idea**, 5-dr MPV, 03-

**FIAT Stilo**, 3-dr Hatchback, 01-07

**FIAT Stilo**, 5-dr Hatchback, 01-07

**LANCIA Musa**, 5-dr MPV, 04- (without glassroof)

This kit is only for vehicles with fixpoint mounting.

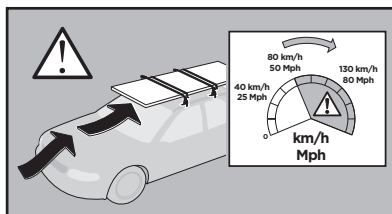
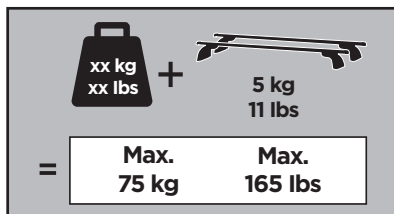
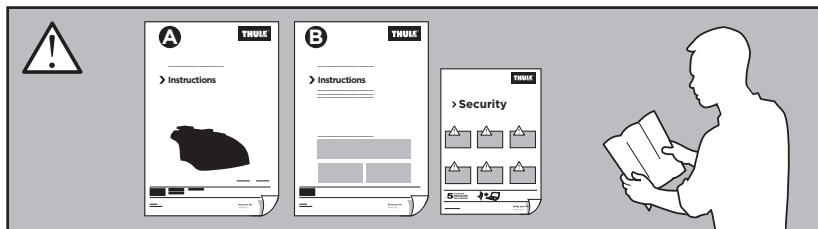

ISO 11154-E

183004

C.20130603  
509-3004-02

Bring your life

thule.com

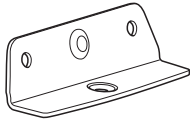

◀ 01 x4

31307  
35 mm x4

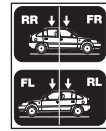

x1

50786 x4

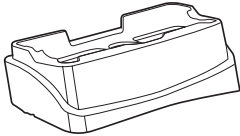

◀ 01 x2

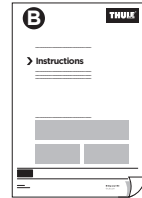

x1

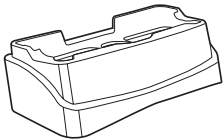

◀ 02 x2

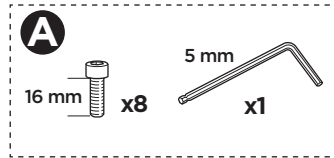

1

01

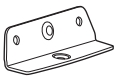

02



01



01

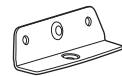

01

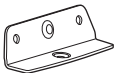

01



02



01

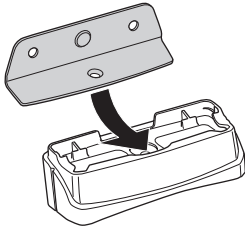
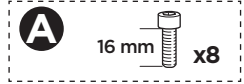

**2****A****B**

- EN** Only a few turns  
**DE** Nur wenige Umdrehungen  
**FR** Quelques tours uniquement  
**NL** Slechts enkele slagen  
**IT** Solo qualche giro  
**ES** Sólo algunas vueltas  
**PT** Noções básicas  
**SV** Endast några varv  
**DK** Kun nogle få omgange  
**NE** Bare noen få omdreinger  
**FI** Vain muutama kierros  
**ET** Ainult mõni pööre  
**LV** Tikai dažī apgriezieni  
**LT** Tik keli pasukimai  
**PL** Wystarczy kilka obrotów  
**RU** Только несколько оборотов

- UK** Лише декілька обертів  
**BG** Само няколко завъртания  
**CS** Pouze několik otáček  
**SK** Len niekoľko otáčok  
**SL** Le nekaj obratov  
**HR/BiH** Samo nekoliko okreta  
**RO** Doar câteva rotiri  
**HU** Csak néhány fordítás  
**EL** Μόνο λίγες περιστροφές  
**TR** Yalnızca birkaç tur

بعض دورات فقط

**AR**

רק מספר סיבובים

**HE**

- ZH** 仅几圈  
**JA** 2～3回転のみ  
**KO** 몇 번만 돌리면 됨  
**TH** เพียงสองสามรอบ

**3**

x1

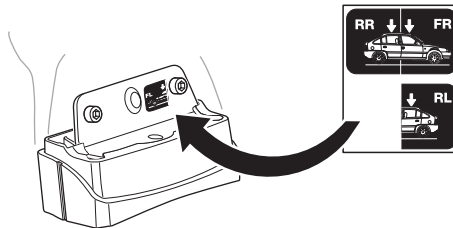

**4**

35 mm  x4  x4

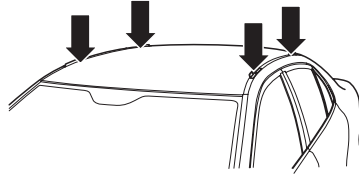
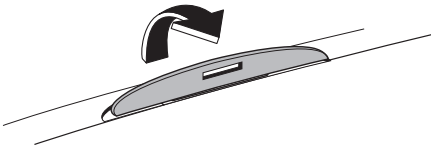
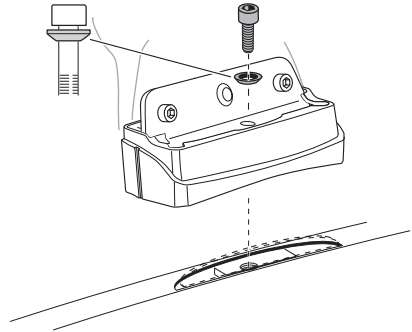
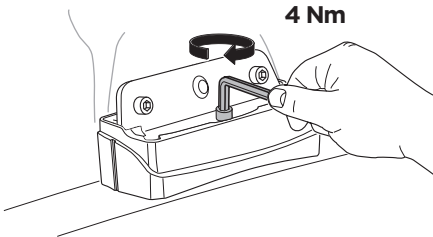
**A****B****5****A****B**