

# Thule Rapid System Kit 1618

# > Instructions

**VOLKSWAGEN Jetta VI**, 4-dr Sedan, 10-

**VOLKSWAGEN Jetta VI**, 4-dr Sedan, \*11-

\*North America

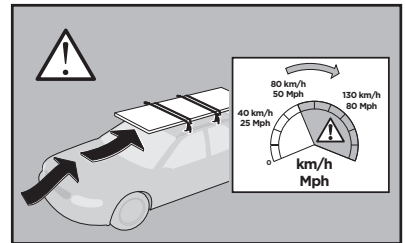
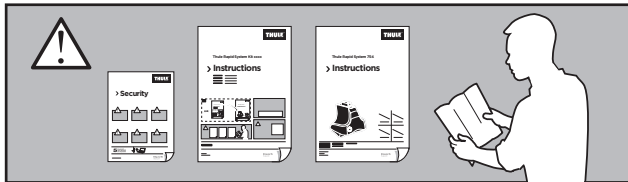
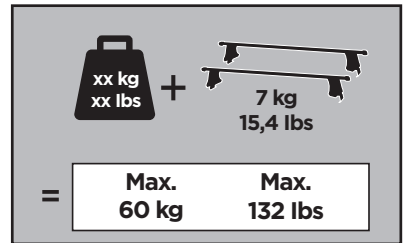
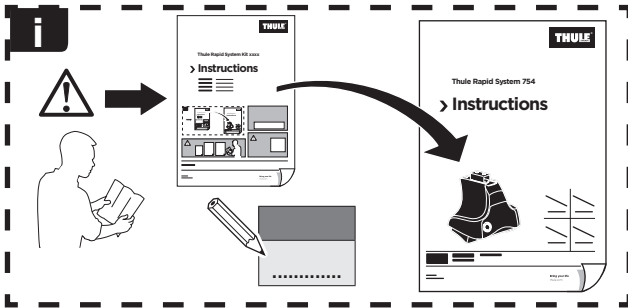

ISO 11154-E

141618

C.20140110  
519-1618-03

Bring your life

thule.com





204 x1

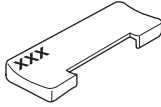

206 x1



1135 x1

1137 x1

340 x1

1149 x2

341 x1

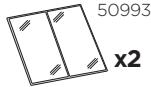

50993 x2



x2



x1



x1

1

	X (scale)	X (mm)	X (inch)
<b>VOLKSWAGEN Jetta VI</b> , 4-dr Sedan, 10-	35	1001	39 <sup>3</sup> / <sub>8</sub>
<b>VOLKSWAGEN Jetta VI</b> , 4-dr Sedan, *11-	35	1001	39 <sup>3</sup> / <sub>8</sub>

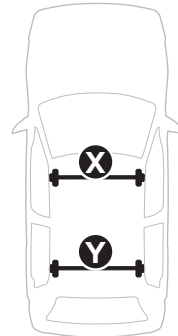
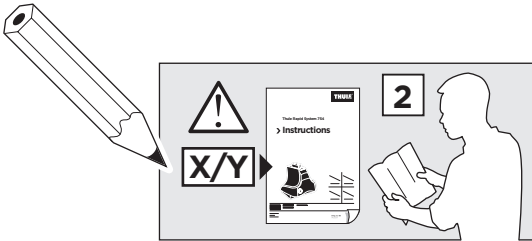

	Y (scale)	Y (mm)	Y (inch)
<b>VOLKSWAGEN Jetta VI</b> , 4-dr Sedan, 10-	31,5	966	38
<b>VOLKSWAGEN Jetta VI</b> , 4-dr Sedan, *11-	30,5	956	37 <sup>5</sup> / <sub>8</sub>

**2**

**VOLKSWAGEN Jetta VI, 4-dr Sedan, 10-**  
**VOLKSWAGEN Jetta VI, 4-dr Sedan, \*11-**

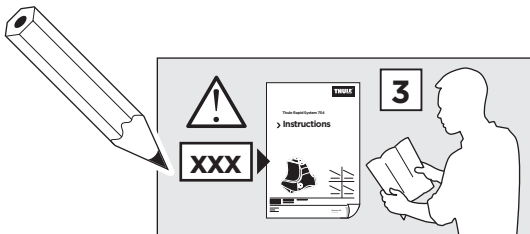
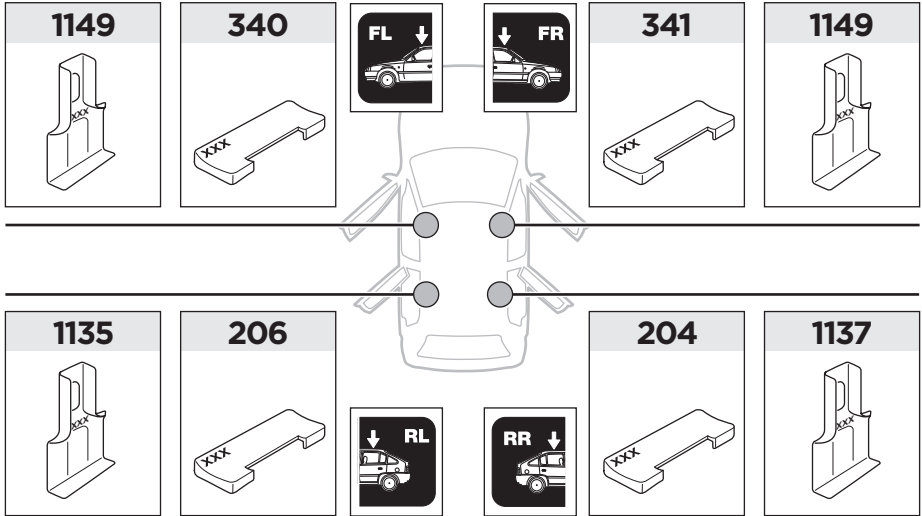

**3**

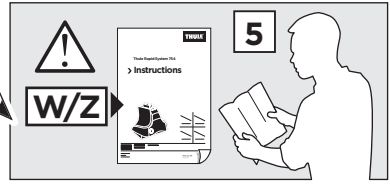
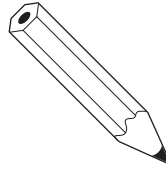

	W (mm)	Z (mm)	W (inch)	Z (inch)
<b>VOLKSWAGEN Jetta VI, 4-dr Sedan, 10-</b>	<b>254</b>	<b>790</b>	<b>10</b>	<b>31 1/8</b>
<b>VOLKSWAGEN Jetta VI, 4-dr Sedan, *11-</b>	<b>254</b>	<b>790</b>	<b>10</b>	<b>31 1/8</b>

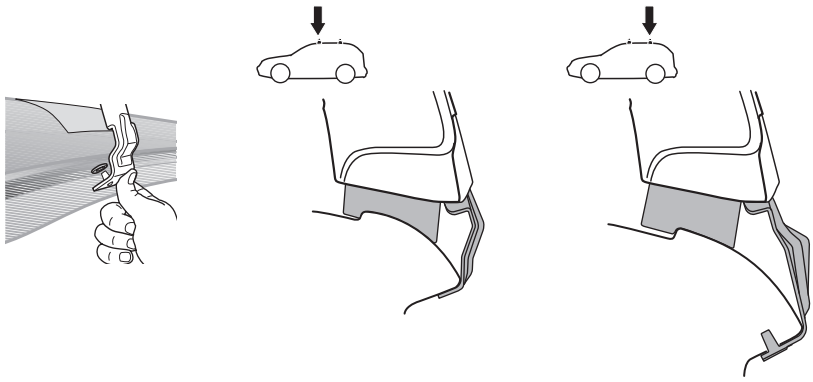
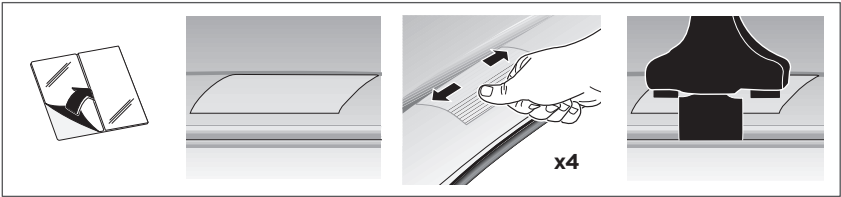
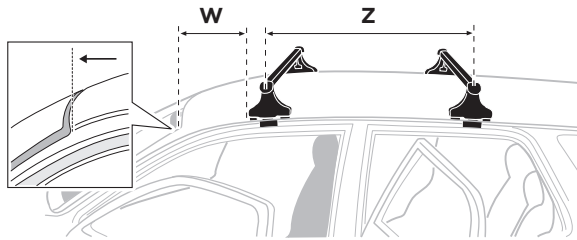

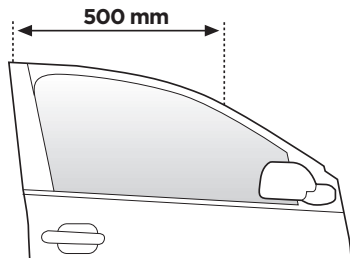
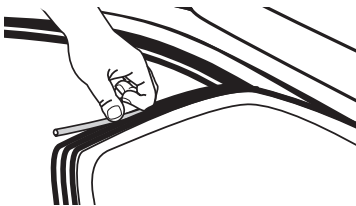
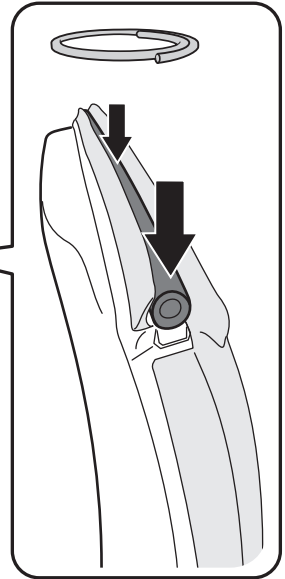
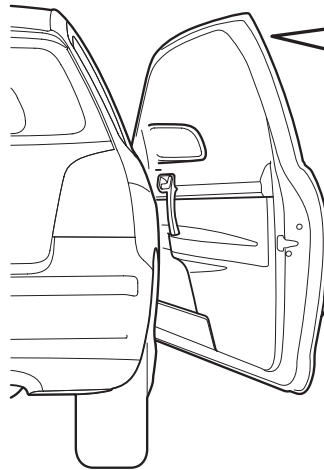
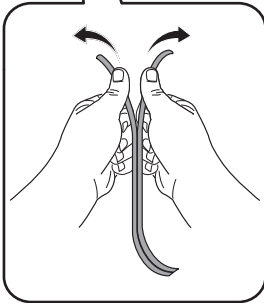
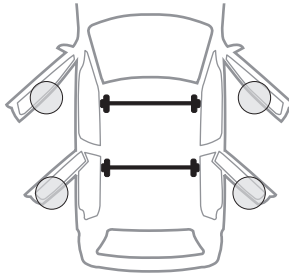

4

VOLKSWAGEN Jetta VI, 4-dr Sedan, 10- /\*11-





**WW** ▶  Thule Sweden AB, Box 69, 330 33 Hillerstorp, SWEDEN  
**NA** ▶  Thule Inc., 42 Silvermine Road, Seymour, Connecticut 06483, USA

 [info@thule.com](mailto:info@thule.com)  
 Phone: 800-238-2388

 [www.thule.com](http://www.thule.com)