

# Thule Rapid System Kit 1604

# > Instructions

**CHRYSLER 300**, 4-dr Sedan, 11-  
**DODGE Charger**, 4-dr Sedan, 11-  
**LANCIA Thema**, 4-dr Sedan, 11-

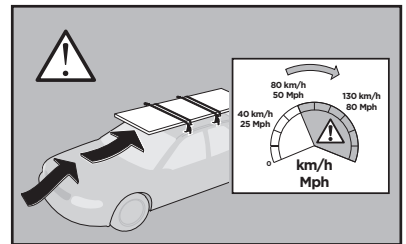
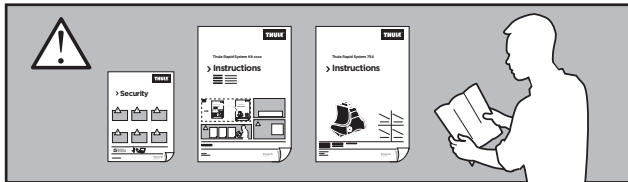
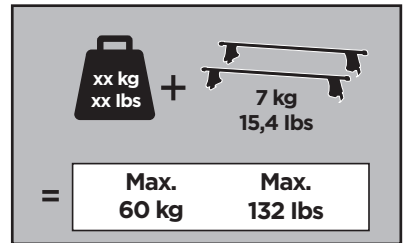
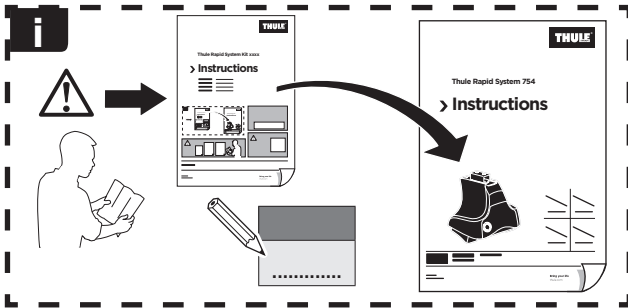

ISO 11154-E



266 x2

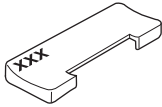

267 x2

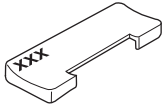

1182 x4



x1

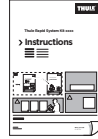

x1

# 1

	X (scale)	X (mm)	X (inch)
<b>CHRYSLER 300</b> , 4-dr Sedan, 11-	46	1111	43 <sup>3</sup> / <sub>4</sub>
<b>DODGE Charger</b> , 4-dr Sedan, 11-	46	1111	43 <sup>3</sup> / <sub>4</sub>
<b>LANCIA Thema</b> , 4-dr Sedan, 11-	46	1111	43 <sup>3</sup> / <sub>4</sub>

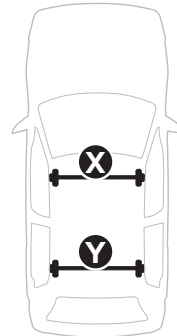
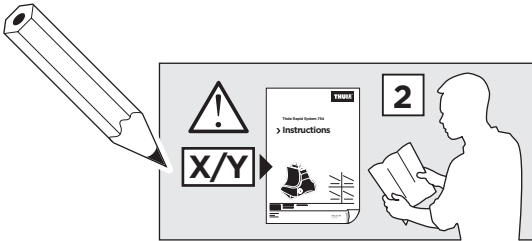

	Y (scale)	Y (mm)	Y (inch)
<b>CHRYSLER 300</b> , 4-dr Sedan, 11-	46,5	1116	40
<b>DODGE Charger</b> , 4-dr Sedan, 11-	46,5	1116	40
<b>LANCIA Thema</b> , 4-dr Sedan, 11-	46,5	1116	40

2

**CHRYSLER 300**, 4-dr Sedan, 11-  
**DODGE Charger**, 4-dr Sedan, 11-  
**LANCIA Thema**, 4-dr Sedan, 11-

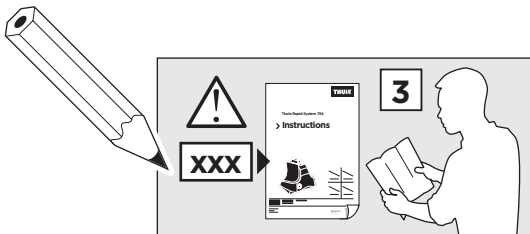
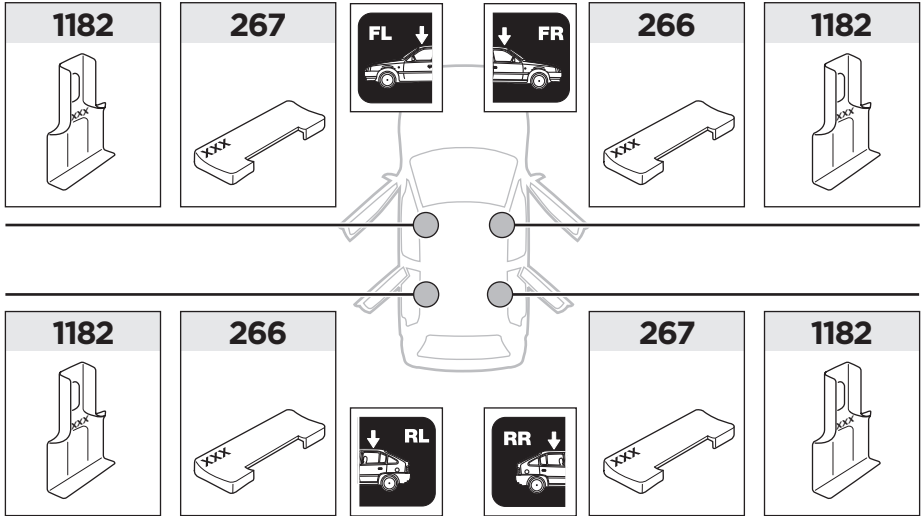

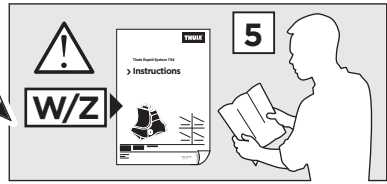
**3**

	W (mm)	Z (mm)	W (inch)	Z (inch)
<b>CHRYSLER 300</b> , 4-dr Sedan, 11-	<b>250</b>	<b>700</b>	<b>9 7/8</b>	<b>27 1/2</b>
<b>DODGE Charger</b> , 4-dr Sedan, 11-	<b>250</b>	<b>700</b>	<b>9 7/8</b>	<b>27 1/2</b>
<b>LANCIA Thema</b> , 4-dr Sedan, 11-	<b>250</b>	<b>700</b>	<b>9 7/8</b>	<b>27 1/2</b>

