

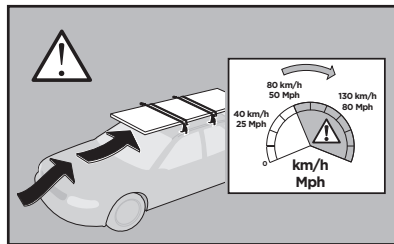

## Thule Rapid System Kit 1562

# > Instructions

HONDA Insight, 5-dr Hatchback, 09-

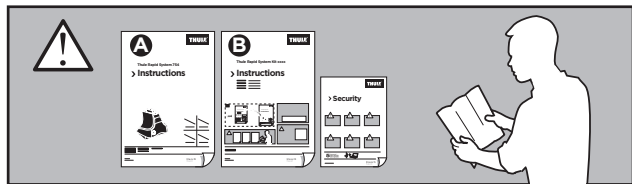
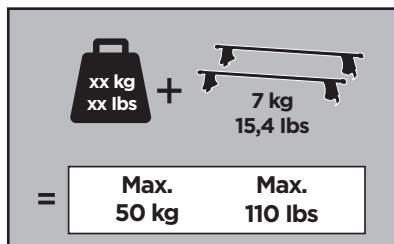
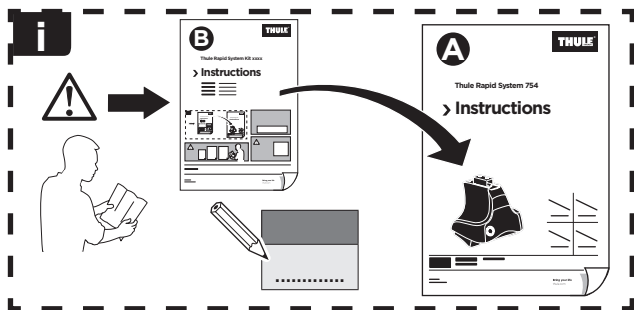

ISO 11154-E

141562

C.20130703  
519-1562-02

Bring your life  
thule.com



999 x2

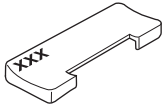

140 x2



x1

1041 x2

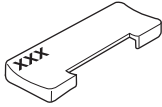

141 x2



x1

1

	X (scale)	X (mm)	X (inch)
<b>HONDA Insight, 5-dr Hatchback, 09-</b>	<b>40</b>	<b>1060</b>	<b>41 <sup>3</sup>/<sub>4</sub></b>

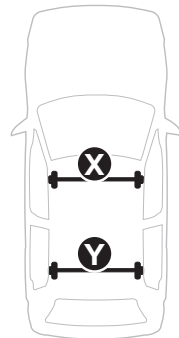
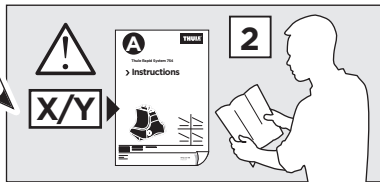
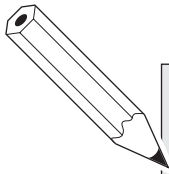

	Y (scale)	Y (mm)	Y (inch)
<b>HONDA Insight, 5-dr Hatchback, 09-</b>	<b>38</b>	<b>1035</b>	<b>40 <sup>3</sup>/<sub>4</sub></b>

**2**

**HONDA Insight, 5-dr Hatchback, 09-**

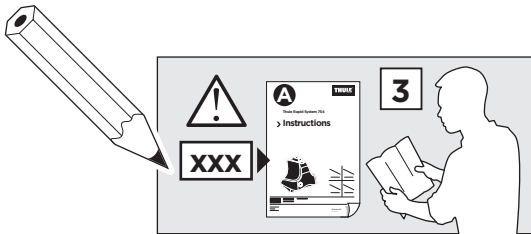
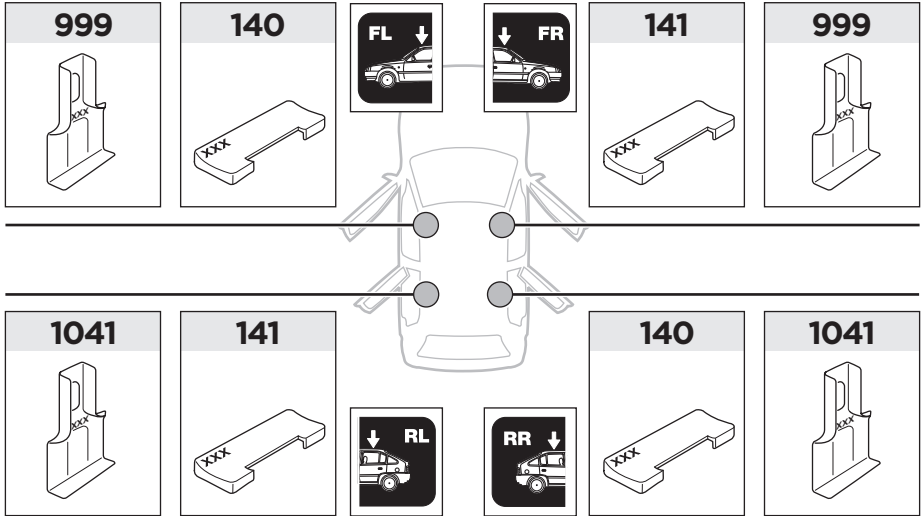

3

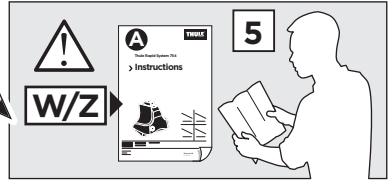
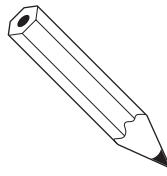

	W (mm)	Z (mm)	W (inch)	Z (inch)
<b>HONDA Insight, 5-dr Hatchback, 09-</b>	<b>325</b>	<b>750</b>	<b>12 3/4</b>	<b>27 1/2</b>

