



## Thule Rapid System Kit 1285

# > Instructions

**OPEL Signum**, 5-dr Hatchback, 03-07

**OPEL Vectra**, 4-dr Sedan, 02-08

**OPEL Vectra GTS**, 5-dr Hatchback, 02-08

**VAUXHALL Signum**, 5-dr Hatchback, 03-07

**VAUXHALL Vectra**, 4-dr Sedan, 02-08

**VAUXHALL Vectra GTS**, 5-dr Hatchback, 02-08

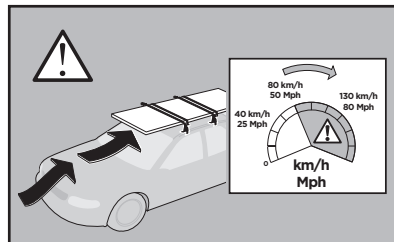
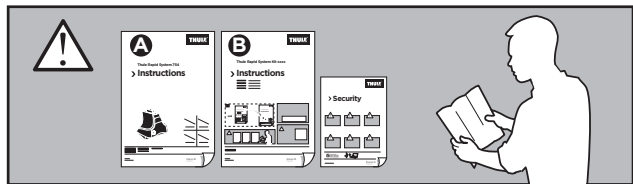
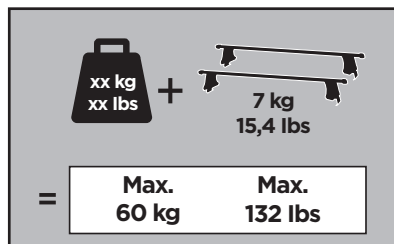
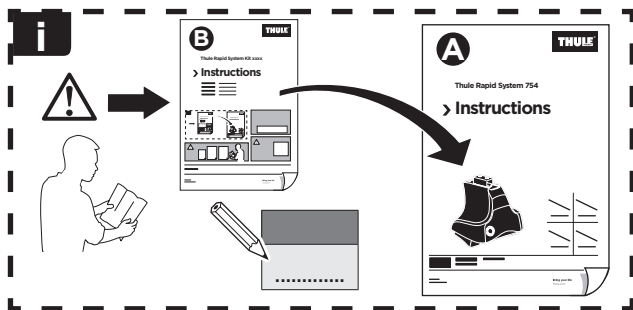

ISO 11154-E

141285

C.20130619  
519-1285-01

Bring your life  
thule.com

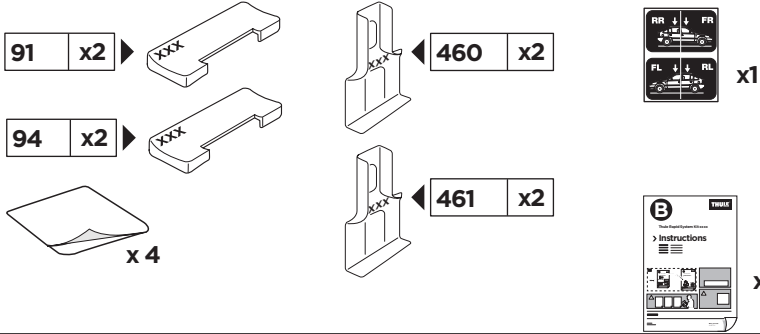

# 1

	X (scale)	X (mm)	X (inch)
<b>OPEL Signum</b> , 5-dr Hatchback, 03-07	39,5	1046	41 <sup>1</sup> / <sub>8</sub>
<b>OPEL Vectra</b> , 4-dr Sedan, 02-08	39	1041	41
<b>OPEL Vectra GTS</b> , 5-dr Hatchback, 02-08	39	1041	41
<b>VAUXHALL Signum</b> , 5-dr Hatchback, 03-07	39,5	1046	41 <sup>1</sup> / <sub>8</sub>
<b>VAUXHALL Vectra</b> , 4-dr Sedan, 02-08	39	1041	41
<b>VAUXHALL Vectra GTS</b> , 5-dr Hatchback, 02-08	39	1041	41

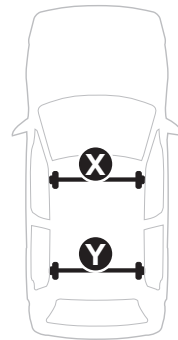
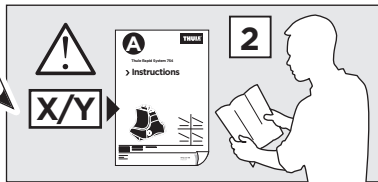
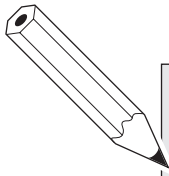

	Y (scale)	Y (mm)	Y (inch)
<b>OPEL Signum</b> , 5-dr Hatchback, 03-07	35,5	1006	39 <sup>5</sup> / <sub>8</sub>
<b>OPEL Vectra</b> , 4-dr Sedan, 02-08	36,5	1016	40
<b>OPEL Vectra GTS</b> , 5-dr Hatchback, 02-08	36,5	1016	40
<b>VAUXHALL Signum</b> , 5-dr Hatchback, 03-07	35,5	1006	39 <sup>5</sup> / <sub>8</sub>
<b>VAUXHALL Vectra</b> , 4-dr Sedan, 02-08	36,5	1016	40
<b>VAUXHALL Vectra GTS</b> , 5-dr Hatchback, 02-08	36,5	1016	40

# 2

**OPEL Signum**, 5-dr Hatchback, 03-07  
**OPEL Vectra**, 4-dr Sedan, 02-08  
**OPEL Vectra GTS**, 5-dr Hatchback, 02-08  
**VAUXHALL Signum**, 5-dr Hatchback, 03-07  
**VAUXHALL Vectra**, 4-dr Sedan, 02-08  
**VAUXHALL Vectra GTS**, 5-dr Hatchback, 02-08

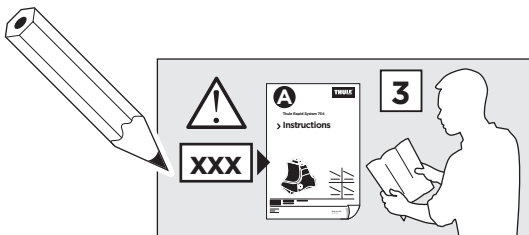
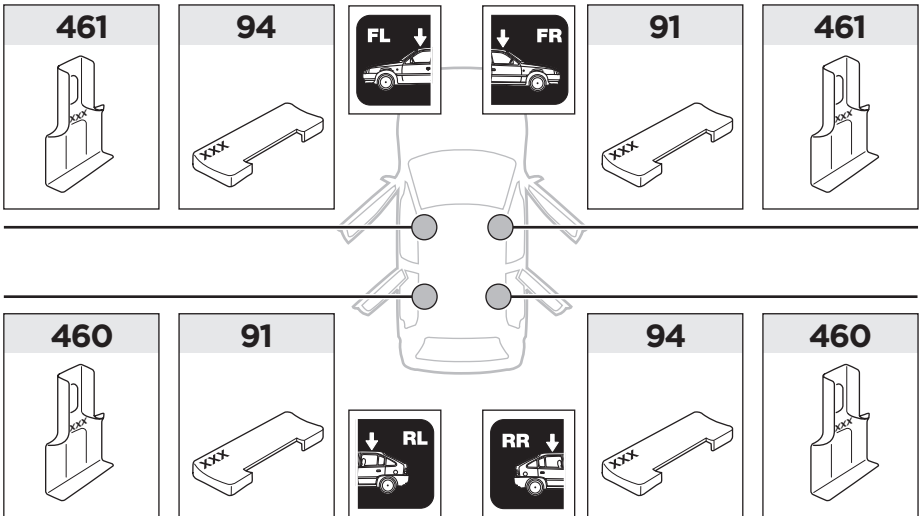
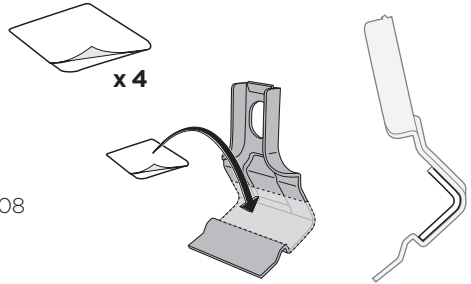

3

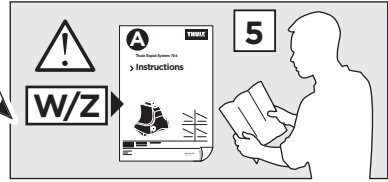

	W (mm)	Z (mm)	W (inch)	Z (inch)
<b>OPEL Signum</b> , 5-dr Hatchback, 03-07	255	700	10	27 1/2
<b>OPEL Vectra</b> , 4-dr Sedan, 02-08	255	700	10	27 1/2
<b>OPEL Vectra GTS</b> , 5-dr Hatchback, 02-08	255	700	10	27 1/2
<b>VAUXHALL Signum</b> , 5-dr Hatchback, 03-07	255	700	10	27 1/2
<b>VAUXHALL Vectra</b> , 4-dr Sedan, 02-08	255	700	10	27 1/2
<b>VAUXHALL Vectra GTS</b> , 5-dr Hatchback, 02-08	255	700	10	27 1/2

