

Kit 1109

NISSAN Mistral, 3-dr SUV, 93-06

NISSAN Mistral, 5-dr SUV, 93-06

NISSAN Terrano II, 3-dr SUV, 93-02, 03-06

NISSAN Terrano II, 5-dr SUV, 93-02, 03-06

FORD Maverick, 3-dr SUV, 93-99

FORD Maverick, 5-dr SUV, 93-99

KIA Sportage, 3-dr SUV, 96-03 / *96-02

KIA Sportage, 5-dr SUV, 94-03, 04-09 / *95-02

*North America

480R
754

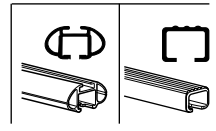
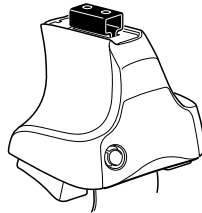

480

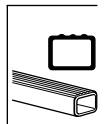
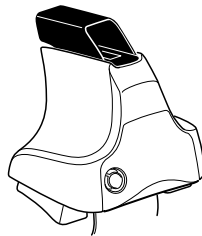

750

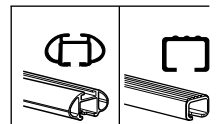
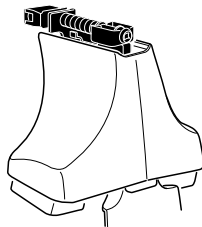

THULE[®]
SWEDEN

ISO 11154-E

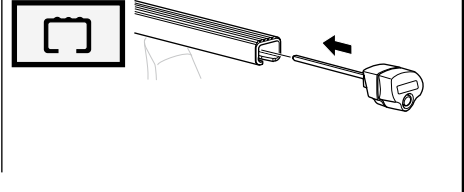
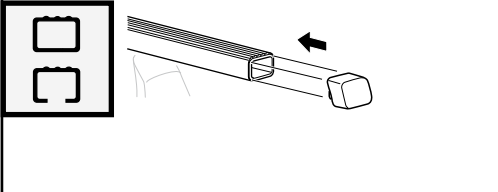
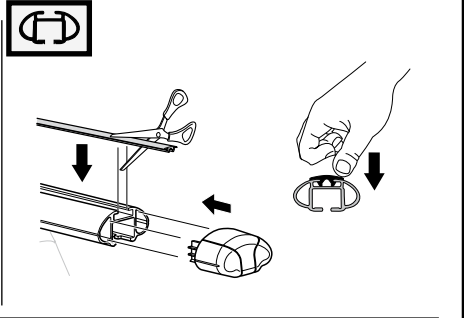
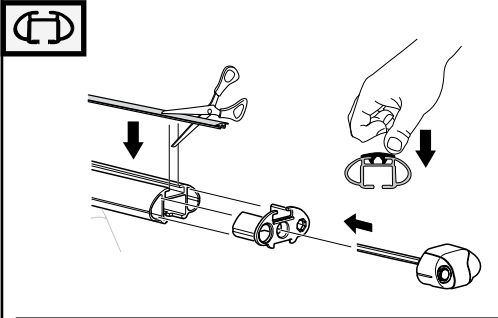
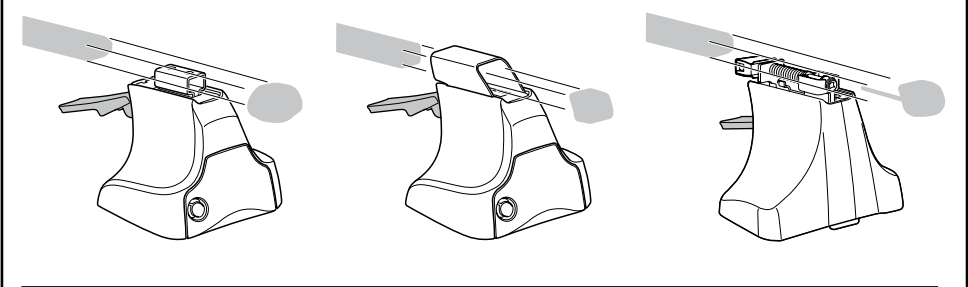
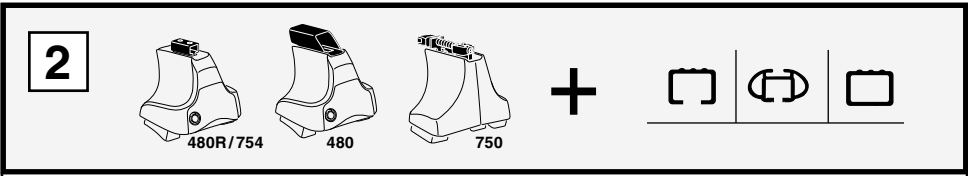
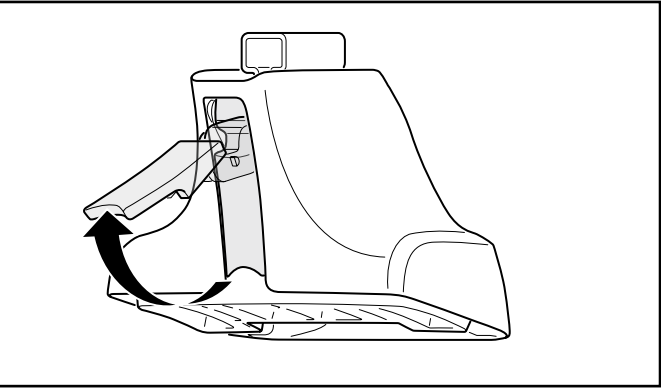
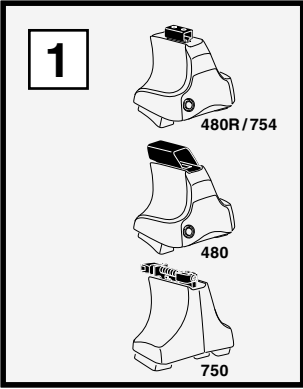

3

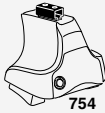

754



750

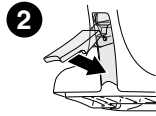
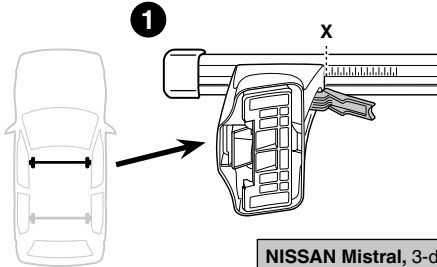

	X
NISSAN Mistral, 3-dr SUV, 93-06	33,5
NISSAN Mistral, 5-dr SUV, 93-06	33,5
NISSAN Terrano II, 3-dr SUV, 93-02, 03-06	33,5
NISSAN Terrano II, 5-dr SUV, 93-02, 03-06	33,5
FORD Maverick, 3-dr SUV, 93-99	33,5
FORD Maverick, 5-dr SUV, 93-99	33,5
KIA Sportage, 3-dr SUV, 96-03 / *96-02	31
KIA Sportage, 5-dr SUV, 94-03, 04-09 / *95-02	31

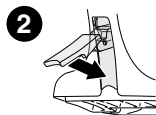
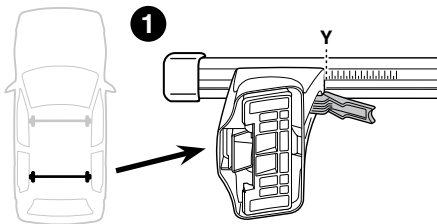

	Y
NISSAN Mistral, 3-dr SUV, 93-06	33,5
NISSAN Mistral, 5-dr SUV, 93-06	32
NISSAN Terrano II, 3-dr SUV, 93-02, 03-06	33,5
NISSAN Terrano II, 5-dr SUV, 93-02, 03-06	32
FORD Maverick, 3-dr SUV, 93-99	33,5
FORD Maverick, 5-dr SUV, 93-99	32
KIA Sportage, 3-dr SUV, 96-03 / *96-02	28,5
KIA Sportage, 5-dr SUV, 94-03, 04-09 / *95-02	28,5

3



480R



480

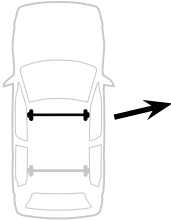
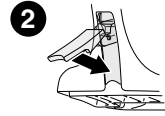
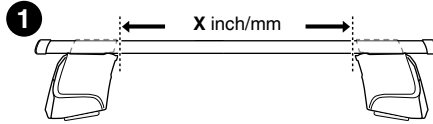

	X inch	X mm
NISSAN Mistral, 3-dr SUV, 93-06	38 $\frac{7}{8}$"	986
NISSAN Mistral, 5-dr SUV, 93-06	38 $\frac{7}{8}$"	986
NISSAN Terrano II, 3-dr SUV, 93-02, 03-06	38 $\frac{7}{8}$"	986
NISSAN Terrano II, 5-dr SUV, 93-02, 03-06	38 $\frac{7}{8}$"	986
FORD Maverick, 3-dr SUV, 93-99	38 $\frac{7}{8}$"	986
FORD Maverick, 5-dr SUV, 93-99	38 $\frac{7}{8}$"	986
KIA Sportage, 3-dr SUV, 96-03 / *96-02	37 $\frac{7}{8}$"	961
KIA Sportage, 5-dr SUV, 94-03, 04-09 / *95-02	37 $\frac{7}{8}$"	961

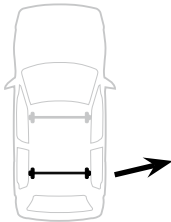
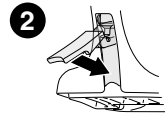
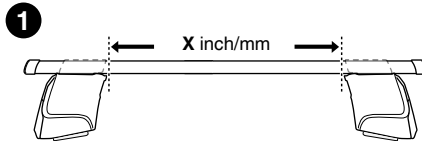

	X inch	X mm
NISSAN Mistral, 3-dr SUV, 93-06	38 $\frac{7}{8}$"	986
NISSAN Mistral, 5-dr SUV, 93-06	38 $\frac{1}{4}$"	971
NISSAN Terrano II, 3-dr SUV, 93-02, 03-06	38 $\frac{7}{8}$"	986
NISSAN Terrano II, 5-dr SUV, 93-02, 03-06	38 $\frac{1}{4}$"	971
FORD Maverick, 3-dr SUV, 93-99	38 $\frac{7}{8}$"	986
FORD Maverick, 5-dr SUV, 93-99	38 $\frac{1}{4}$"	971
KIA Sportage, 3-dr SUV, 96-03 / *96-02	36 $\frac{7}{8}$"	936
KIA Sportage, 5-dr SUV, 94-03, 04-09 / *95-02	36 $\frac{7}{8}$"	936

4

NISSAN Mistral, 3-dr SUV, 93-06
 NISSAN Terrano II, 3-dr SUV, 93-02, 03-06
 FORD Maverick, 3-dr SUV, 93-99
 KIA Sportage, 3-dr SUV, 96-03 / *96-02

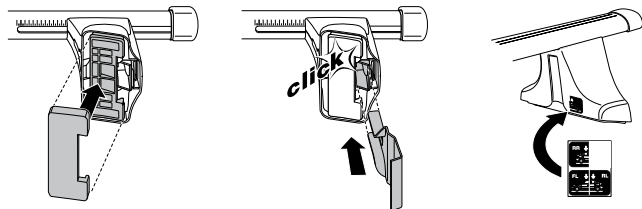
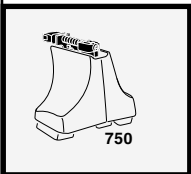
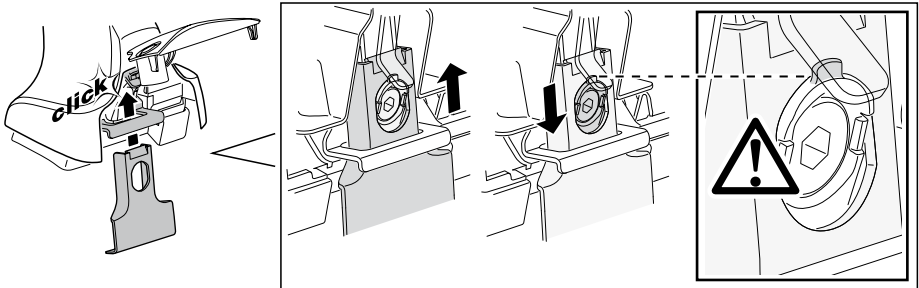
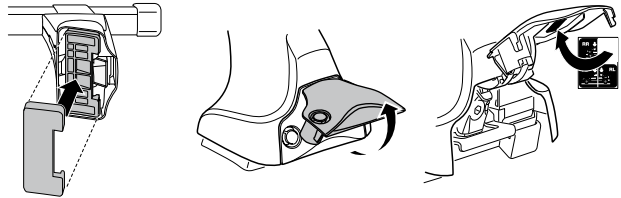
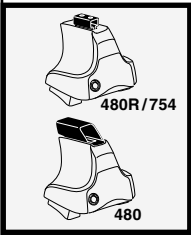
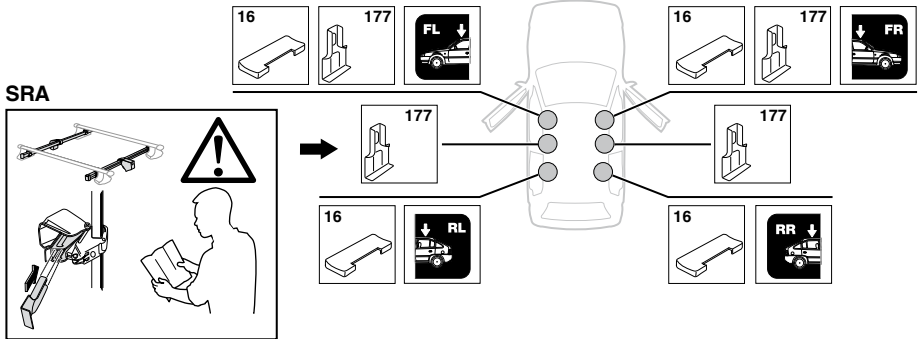

4

NISSAN Mistral, 5-dr SUV, 93-06

NISSAN Terrano II, 5-dr SUV, 93-02, 03-06

FORD Maverick, 5-dr SUV, 93-99

KIA Sportage, 5-dr SUV, 94-03, 04-09 / *95-02

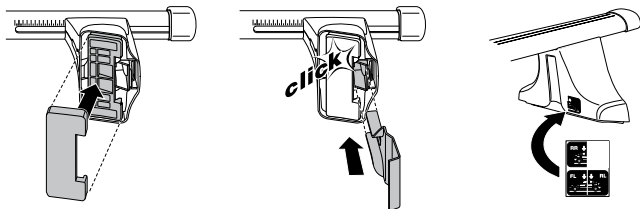
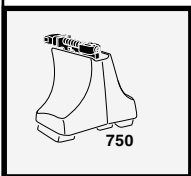
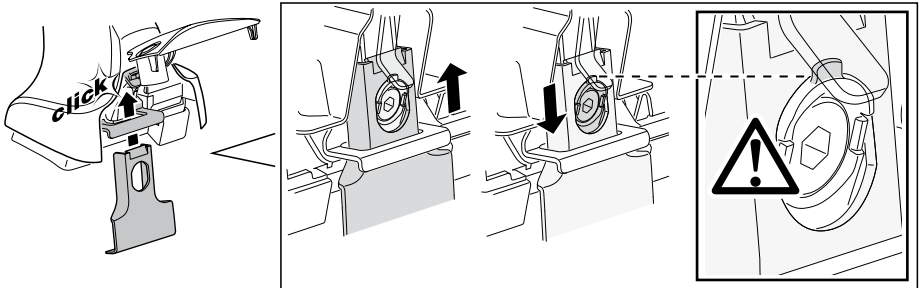
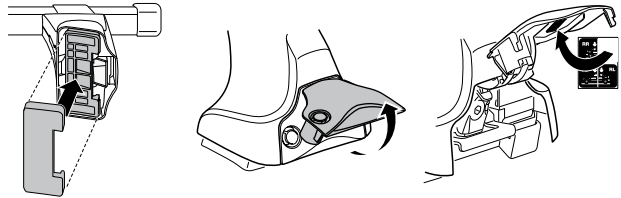
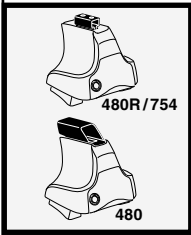
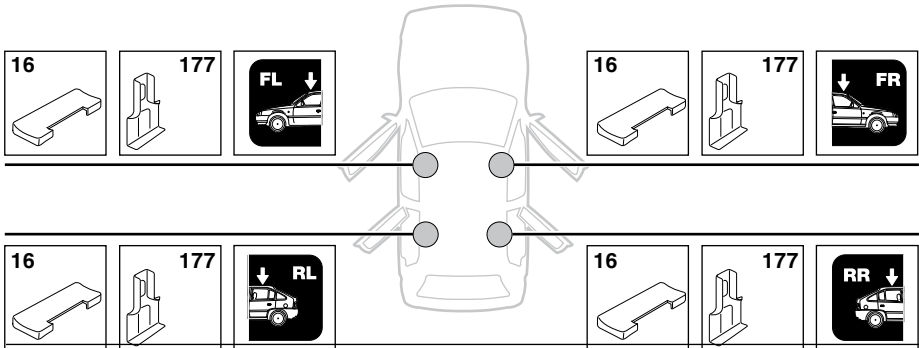

5

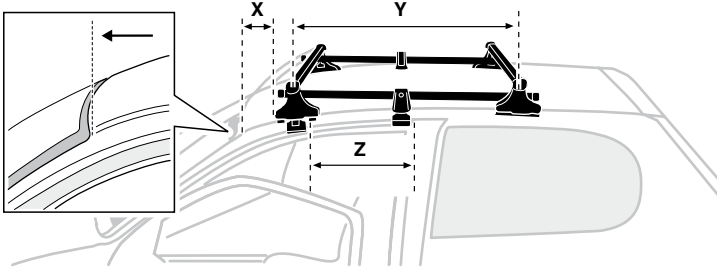
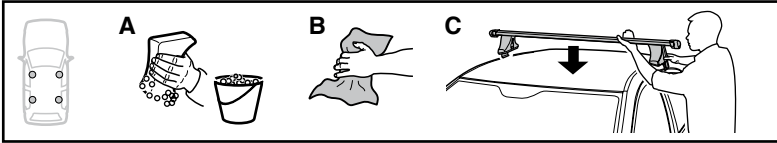

	X mm	Y mm	Z mm	X inch	Y inch	Z inch
NISSAN Mistral , 3-dr SUV, 93-06	180 mm	700 mm	290 mm	7 1/8"	27 1/2"	11 3/8"
NISSAN Terrano II , 3-dr SUV, 93-02, 03-06	180 mm	700 mm	290 mm	7 1/8"	27 1/2"	11 3/8"
FORD Maverick , 3-dr SUV, 93-99	180 mm	700 mm	290 mm	7 1/8"	27 1/2"	11 3/8"
KIA Sportage , 3-dr SUV, 96-03 / *96-02	220 mm	700 mm	330 mm	8 5/8"	27 1/2"	13"

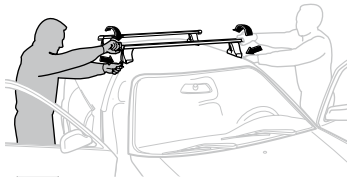
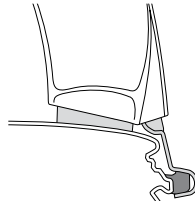

GB/US Tighten alternately

D Die Schrauben abwechselnd anziehen

F Serrer alternativement chaque côté

NL Afwisselend aan de linker- en de rechterkant aandraaien

I Alternare il serraggio delle viti

E Serrare alternativamente

PT Aperte alternadamente

S Dra åt växelvis

FIN Kierrä vuorotellen

EST Pinguldage vaheldumisi

LAT Pievelciēt pamišus

LIT Užsukinėkite pakaitomis

PL Śruby dokręcaj naprzemiennie

RU Затягивайте попеременно

CZ Pokręťta багаžníka dokręcaj dokręcaj naprzemiennie.

SK Doťahujte striedavo

SLO Privijajte izmenično.

HR Naizmjenično zategnite

HU Egymástól függetlenül szorítandó

GR Σφιγγετε εναλλάξ

TR Dönüşümlü sıkın

中文 交替拧紧

한국어 번갈아 가며 조이십시오.

日本語 交互に締め付けてください。

ไทย ชับในแบบสลับ

5

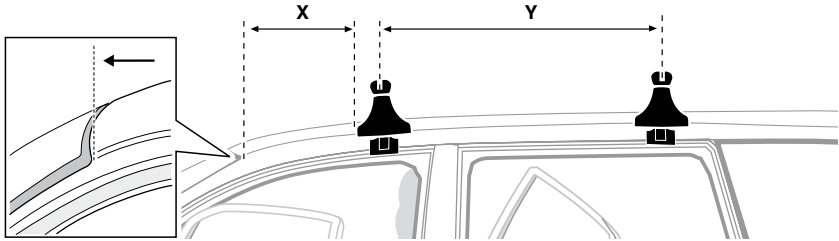
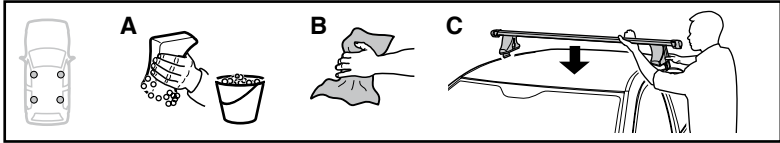

	X mm	Y mm	X inch	Y inch
NISSAN Mistral , 5-dr SUV, 93-06	180 mm	700 mm	7 1/8"	27 1/2"
NISSAN Terrano II , 5-dr SUV, 93-02, 03-06	180 mm	700 mm	7 1/8"	27 1/2"
FORD Maverick , 5-dr SUV, 93-99	180 mm	700 mm	7 1/8"	27 1/2"
KIA Sportage , 5-dr SUV, 94-03, 04-09 / *95-02	270 mm	700 mm	10 5/8"	27 1/2"

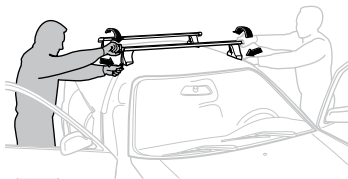
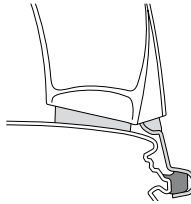

GB/US Tighten alternately

D Die Schrauben abwechselnd anziehen

F Serrer alternativement chaque côté

NL Afwisselend aan de linker- en de rechterkant aandraaien

I Alternare il serraggio delle viti

E Serrare alternativamente

PT Aperte alternadamente

S Dra åt växelvis

- FIN** Kierrä vuorotellen
- EST** Pinguldage vaheldumisi
- LAT** Pielieciet pamišus
- LIT** Užsukinėkite pakaitomis
- PL** Śruby dokręcaj naprzemiennie
- RU** Затягивайте попеременно
- CZ** Pokręťta багаžníka dokręcaj dokręcaj naprzemiennie.
- SK** Doťahujte striedavo
- SLO** Privijajte izmenično.
- HR** Naizmjenično zategnite
- HU** Egymástól függetlenül szorítandó
- GR** Σφίγγετε εναλλάξ
- TR** Dönüşümlü sıkın
- 中文** 交替拧紧
- 한국어** 번갈아 가며 조이십시오.
- 日本語** 交互に締め付けてください。
- ไทย** ขันในแบบสลับ

6

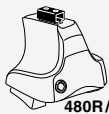

480R/754



480

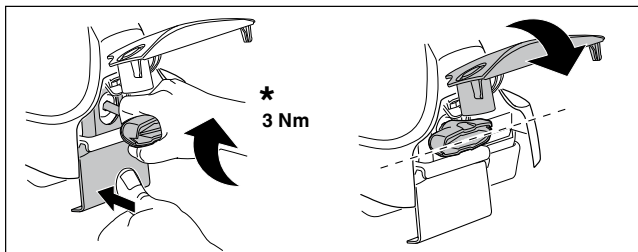
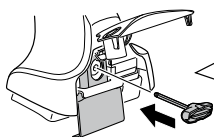

*
3 Nm

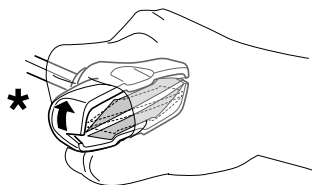

*

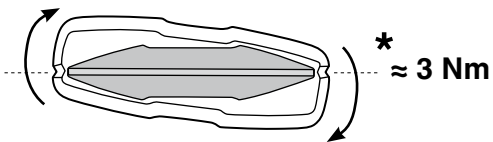

*
≈ 3 Nm

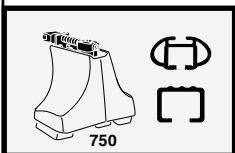
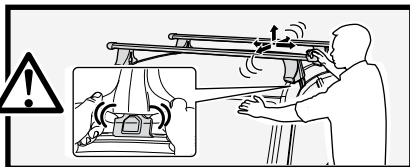

750

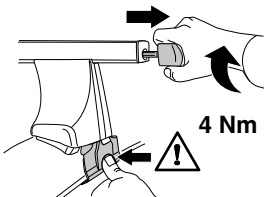

4 Nm

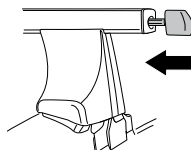

7



x1
17 mm

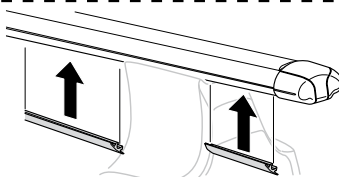

i

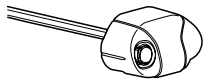

1

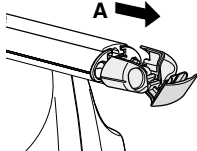

2

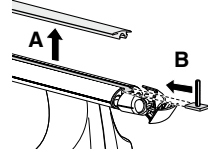

i



1

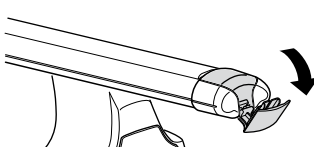

2

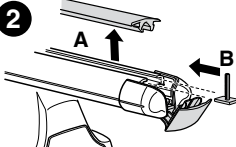

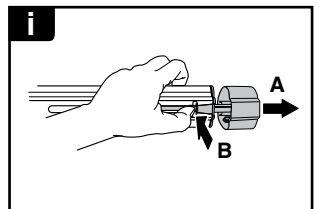
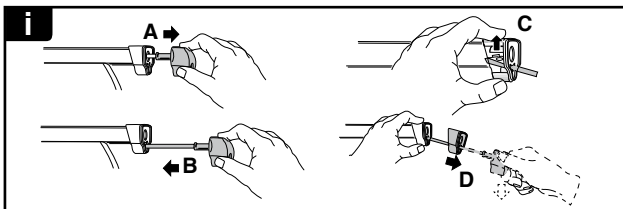
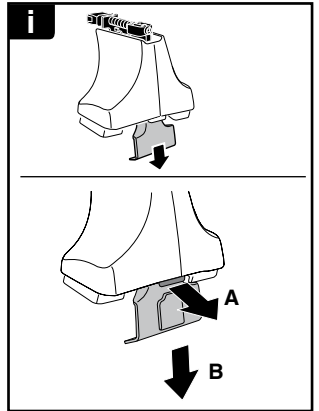
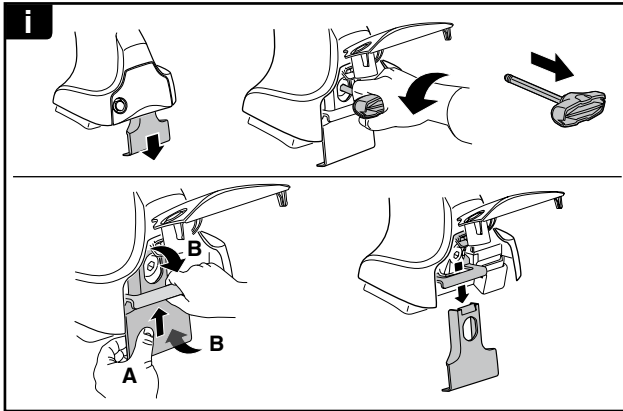
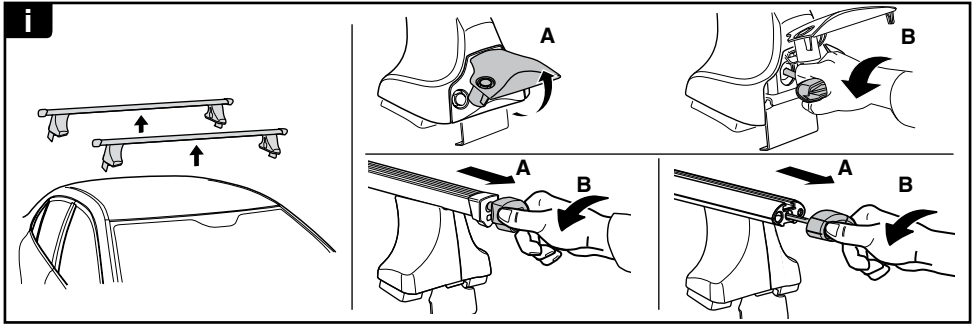

THULE
SWEDEN
**ONE
KEY
SYSTEM**

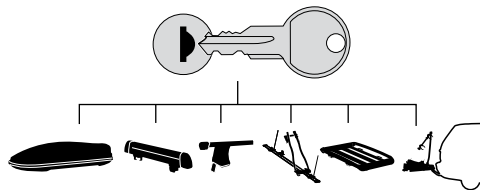

		544	(x4)
		596	(x6)
		588	(x8)
NA		510	(x10)
EUR		452	(x12)
ASIA			

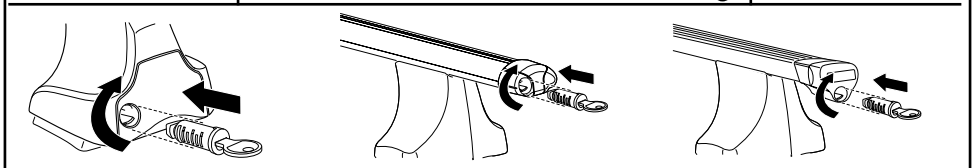

WW ▶ Thule Sweden AB, Box 69, 330 33 Hillerstorp, SWEDEN
NA ▶ Thule Inc., 42 Silvermine Road, Seymour, Connecticut 06483, USA

info@thule.com
customer.service@thule.com

www.thule.com